



VESTIL MANUFACTURING CORP.

2999 North Wayne Street, P.O. Box 507, Angola, IN 46703
Telephone: (260) 665-7586 -or- Toll Free (800) 348-0868

Fax: (260) 665-1339

www.vestilmfg.com e-mail: sales@vestil.com

EHN-20-C INSTRUCTION MANUAL



Receiving instructions:

After delivery, IMMEDIATELY remove the packaging from the product in a manner that preserves the packaging and maintains the orientation of the product in the packaging; then inspect the product closely to determine whether it sustained damage during transport. **If damage is discovered during the inspection, immediately record a complete description of the damage on the bill of lading.** If the product is undamaged, discard the packaging.

NOTES:

- 1) Compliance with laws, regulations, codes, and non-voluntary standards enforced in the location where the product is *used* is exclusively the responsibility of the owner/end-user.
- 2) VESTIL is **not liable** for any injury or property damage that occurs as a consequence of failing to apply either: a) the instructions in this manual; or b) information provided on labels affixed to the product. Neither is Vestil responsible for *any* consequential damages sustained as a result of failing to exercise sound judgment while assembling, installing, using or maintaining this product.





Table of Contents

Hazard identification: explanation of signal words.....	2
Safety Guidelines.....	2
Exploded parts diagrams and bills of materials.....	3
Label placement diagram	4
Limited warranty.....	5

HAZARD IDENTIFICATION: explanation of signal words

This manual uses SIGNAL WORDS to indicate the likelihood of personal injuries, as well as the probable seriousness of those injuries, if the product is misused in the ways described. Other signal words call attention to uses of the product likely cause property damage.

The signal words used appear below along with the meaning of each word:

	Identifies a hazardous situation which, if not avoided, WILL result in DEATH or SERIOUS INJURY . Use of this signal word is limited to the most extreme situations.
	Identifies a hazardous situation which, if not avoided, COULD result in DEATH or SERIOUS INJURY .
	Indicates a hazardous situation which, if not avoided, COULD result in MINOR or MODERATE injury.
	Identifies practices likely to result in product/property damage, such as operation that might damage the product.

Each person who assembles, installs, uses, or maintains this product should read the entire manual **and fully understand the directions in advance. If after reading the manual you do not understand an instruction, ask your supervisor or employer for clarification, because failure to adhere to the directions in this manual might result in serious personal injury.**

SAFETY GUIDELINES

Vestil diligently strives to identify foreseeable hazards associated with the use of its products. However, material handling is inherently dangerous and no manual can address every conceivable risk. The end-user ultimately is responsible for exercising sound judgment at all times.

 Electrocutation might result if any part of the product contacts electrified wires. Reduce the likelihood of electrocution by applying **common sense**:

- DO NOT *contact* electrified wires with any part of this device, your body, or clothing.
- DO NOT use or store the product where contact with electrified wires is likely.
- Always inspect the usage area before using the product & implement precautions that account for conditions.

 If this product is used improperly or carelessly, the operator and/or bystanders might sustain serious personal injuries or even be killed. To reduce the likelihood of injury:

- **Failure to read and understand the entire manual before assembling, installing, using or servicing the product is a misuse of the product.**
- Read the manual to refresh your understanding of proper use and maintenance procedures.
- DO NOT attempt to resolve any problem(s) with the product unless you are both authorized to do so and certain that it will be safe to use afterwards.
- DO NOT modify the product in any way UNLESS you first obtain written approval from Vestil. Unauthorized modifications automatically void the Limited Warranty and might make the product unsafe to use.
- DO NOT exceed the maximum rated load (see Label 287 on product).
- Inspect the product before each use.
 - A. DO NOT use this product if the inspection reveals structural damage. Examples of structural damage include, but are not limited to, the following: 1) Cracked, broken or significantly deformed load-bearing members; 2) cracked welds; 3) missing or deformed safety chain/strap; 3) corrosion, severe wear, or other condition that affects the ability of the product to support weight or itself. Replace each part that fails to pass an inspection, and DO NOT use the product until it is fully restored to normal condition.
 - B. DO NOT use the product if any unusual noise or movement is observed. If a malfunction occurs, remove the unit from service and notify your supervisor & maintenance personnel about the issue.
- DO NOT use this device UNLESS all product labels (see “Label Placement Diagram”) are readable and undamaged.

 Proper use, maintenance, and storage are essential for this product to function properly.

- Always use this product in accordance with the instructions in this manual and consistent with any training relevant to machines, devices, etc. used in conjunction with this product.
- Keep the product clean & dry. Lubricate moving parts.
- FOR HYDRAULIC UNITS: Do not use brake fluid or jack oils in the hydraulic system. If oil is needed, use an anti-wear hydraulic oil with a viscosity grade of 150 SUS at 100°F, (ISO 32 cSt @ 40°C), or Dexron transmission fluid.
- Contact the manufacturer for MSDS information

Exploded Parts Diagram and Bill of Materials

EHN-20-C (2015)

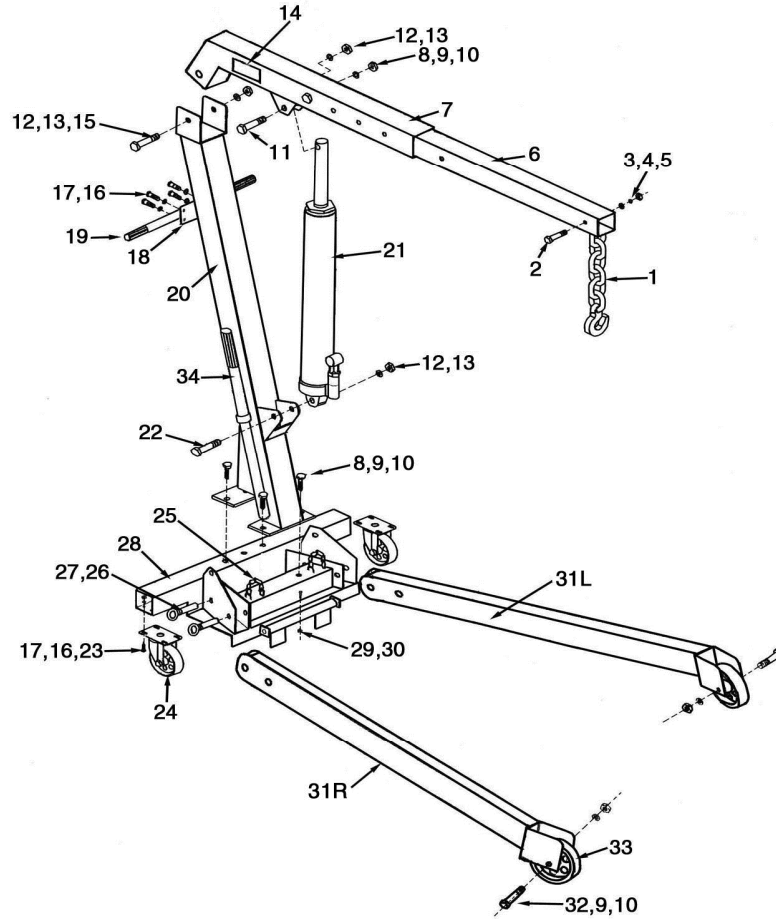

Main Assembly Parts List

Part No.	Description	Q'ty	Part No.	Description	Q'ty
EHN-20-C15-1	Assembly, Chain & Hook	1	EHN-20-C15-19	Grip, Handle	2
EHN-20-C15-2	Bolt, Hex Head	1	EHN-20-C15-20	Post, Main	1
EHN-20-C15-3	Washer, Flat	1	EHN-20-C15-21	Assembly, Pump	1
EHN-20-C15-4	Washer, Lock	1	EHN-20-C15-22	Bolt, Hex Head	1
EHN-20-C15-5	Nut, Hex	1	EHN-20-C15-23	Nut, Hex	8
EHN-20-C15-6	Boom Extension	1	EHN-20-C15-24	Caster, Swivel	2
EHN-20-C15-7	Boom	1	EHN-20-C15-25	Chain	2
EHN-20-C15-8	Bolt, Hex Head	6	EHN-20-C15-26	Pin, Lock	4
EHN-20-C15-9	Washer, Flat	8	EHN-20-C15-27	Pin, Split	4
EHN-20-C15-10	Nut, Hex	8	EHN-20-C15-28	Base	1
EHN-20-C15-11	Bolt, Hex Head	1	EHN-20-C15-29	Bolt, Hex Head	1
EHN-20-C15-12	Washer, Flat	3	EHN-20-C15-30	Nut, Hex	1
EHN-20-C15-13	Nut, Hex	3	EHN-20-C15-31R	Leg, Right	1
EHN-20-C15-14	Label, Warning	1	EHN-20-C15-31L	Leg, Left	1
EHN-20-C15-15	Bolt, Hex Head	1	EHN-20-C15-32	Bolt, Hex Head	2
EHN-20-C15-16	Bolt, Hex Head	12	EHN-20-C15-33	Caster, Fixed	2
EHN-20-C15-17	Washer, Lock	12	EHN-20-C15-34	Handle, Jack	1
EHN-20-C15-18	Handle	1			

Label Placement Diagram

EHN-20-C

⚠ WARNING	⚠ ADVERTENCIA	⚠ AVERTISSEMENT
<ul style="list-style-type: none"> • DO NOT exceed rated capacity • LOWER LOAD before rising to avoid load swing • NEVER STAND under, beside or in front of load • USE correct load level indicator • INSPECT connections before using • READ manual before use 	<ul style="list-style-type: none"> • No exceda la capacidad nominal • Descienda la carga antes de mover para evitar que la carga se balancee • Nunca se abra debajo, al lado o delante de la carga • Use el nivel superior a nivel correcto • Inspeccione las conexiones antes del uso • Lea el manual antes del uso 	<ul style="list-style-type: none"> • NE PAS DÉPASSER la capacité nominale • DÉSCENDEZ la charge avant de la transporter pour éviter la réaction • N'ALLÉZ sous, à côté ou en face d'une charge • UTILISEZ sur ce site plus si nécessaire • INSPECTEZ l'état des connexions avant d'utiliser • LIRE le guide avant utilisation

Operator Side

586



Both Sides 582

Operator Side

MODEL/NO DE LO/MODELE	
CAPACITY	lbs.
CAPACIDAD/CAPACITE	kg.
SERIAL/SERIE/SERIE	
VESTIL MANUFACTURING CORPORATION	
sales@vestil.com www.vestil.com	

287



ENGINE HOIST

Shop Crane

6/28/05

LIMITED WARRANTY

Vestil Manufacturing Corporation ("Vestil") warrants this product to be free of defects in material and workmanship during the warranty period. *Our warranty obligation is to provide a replacement for a defective original part if the part is covered by the warranty, after we receive a proper request from the warrantee (you) for warranty service.*

Who may request service?

Only a warrantee may request service. *You are a warrantee if you purchased the product from Vestil or from an authorized distributor AND Vestil has been fully paid.*

What is an "original part"?

An original part is a part *used to make the product as shipped* to the warrantee.

What is a "proper request"?

A request for warranty service is proper if Vestil receives: 1) a photocopy of the Customer Invoice that displays the shipping date; AND 2) a written request for warranty service including your name and phone number. Send requests by any of the following methods:

Mail
Vestil Manufacturing Corporation
2999 North Wayne Street, PO Box 507
Angola, IN 46703

Fax
(260) 665-1339
Phone
(260) 665-7586

Email
sales@vestil.com

In the written request, list the parts believed to be defective and include the address where replacements should be delivered.

What is covered under the warranty?

After Vestil receives your request for warranty service, an authorized representative will contact you to determine whether your claim is covered by the warranty. Before providing warranty service, Vestil may require you to send the entire product, or just the defective part or parts, to its facility in Angola, IN. The warranty covers defects in the following *original* dynamic components: motors, hydraulic pumps, electronic controllers, switches and cylinders. It also covers defects in *original* parts that wear under normal usage conditions ("wearing parts"): bearings, hoses, wheels, seals, brushes, batteries, and the battery charger.

How long is the warranty period?

The warranty period for original components is 30 days. The warranty period begins on the date when Vestil ships the product to the warrantee. If the product was purchased from an authorized distributor, the period begins when the distributor ships the product. Vestil may extend the warranty period for products shipped from authorized distributors by *up to* 30 days to account for shipping time.

If a defective part is covered by the warranty, what will Vestil do to correct the problem?

Vestil will provide an appropriate replacement for any *covered* part. An authorized representative of Vestil will contact you to discuss your claim.

What is not covered by the warranty?

1. Labor;
2. Freight;
3. Occurrence of any of the following, which automatically voids the warranty:
 - Product misuse;
 - Negligent operation or repair;
 - Corrosion or use in corrosive environments;
 - Inadequate or improper maintenance;
 - Damage sustained during shipping;
 - Collisions or other incidental contacts causing damage to the product;
 - Unauthorized modifications: DO NOT modify the product IN ANY WAY without first receiving written authorization from Vestil. Modification(s) might make the product unsafe to use or might cause excessive and/or abnormal wear.

Do any other warranties apply to the product?

Vestil Manufacturing Corp. makes no other express warranties. All implied warranties are disclaimed to the extent allowed by law. Any implied warranty not disclaimed is limited in scope to the terms of this Limited Warranty.

